



---

## 1.0 PRODUCT DESCRIPTION

---

### Available Sizes

- 1 – 2"/DN25 – DN50

### Pressure Class

- Up to 300 psi/2068 kPa/21 Bar

### Test Orifice K-Factor

- 1"/DN25 - K2.8 (4.0)
- 1 ¼"/DN32 – K4.2 (6.0)
- 2"/DN50 – K5.6 (8.1)

### Available Connections

- 1"/DN25 – NPT/IGS
- 1 ¼"/DN32 – NPT/OGS
- 2"/DN50 – NPT/OGS

### Ports

- (2) Integrated ports with clear Polycarbonate plugs, allowing for a visual indication water is flowing

### Standard

- Preinstalled Series ARV (refer to [publication 30.74](#)) and plastic tubing.

---

## 2.0 CERTIFICATION/LISTINGS

---

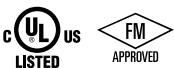

---

## 3.0 SPECIFICATIONS – MATERIAL

---

**3 Way Test and Drain Body:** Brass

**UTD Test and Drain Ball:** Chrome-plated brass

**UTD Test and Drain Handle Stem:** Stainless Steel

**3-Way Test and Drain Stem O-Ring:** EPDM

**UTD Test and Drain Seal:** PTFE

**Sight Glass:** Polycarbonate

**3-Way Red Handle:** EPDM

**Retaining Nut:** Stainless Steel

ALWAYS REFER TO ANY NOTIFICATIONS AT THE END OF THIS DOCUMENT REGARDING PRODUCT INSTALLATION, MAINTENANCE OR SUPPORT.

4.0 DIMENSIONS

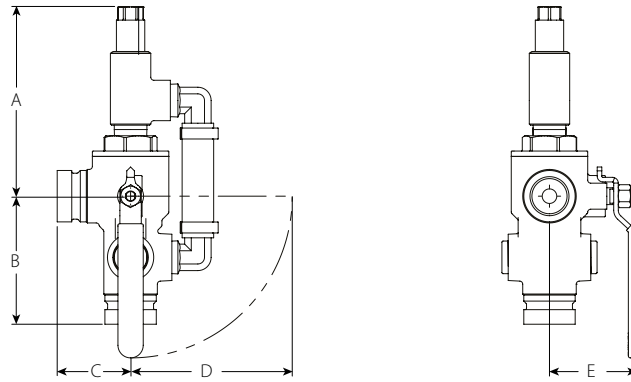





Size		Dimensions					Weight
Nominal inches DN	Actual Outside Diameter inches mm	A inches mm	B inches mm	C inches mm	D inches mm	E inches mm	Approximate (Each) lb kg
1 DN25	1.315 33.7	4.88 124	3.25 83	1.88 48	4.13 105	2.13 54	3.3 1.5
1 1/4 DN32	1.660 42.4	5.00 127	3.38 86	2.25 57	4.88 124	2.63 67	4.6 2.1
2 DN50	2.375 60.3	5.50 140	3.75 95	2.75 70	6.00 152	3.38 86	8.2 3.7

## 5.0 PERFORMANCE

Size		Maximum Working Pressure
Nominal inches DN	Actual Outside Diameter inches mm	
1 DN25	1.315 33.7	300 2068
1 ¼ DN32	1.660 42.4	300 2068
2 DN50	2.375 60.3	300 2068

## 6.0 NOTIFICATIONS

**⚠ WARNING**

- Read and understand all instructions before attempting to install, remove, adjust, or maintain any Victaulic piping products.
- Depressurize and drain the piping system before attempting to install, remove, adjust, or maintain any Victaulic piping products.
- Wear safety glasses, hardhat, and foot protection.

**Failure to follow these instructions could result in death or serious personal injury and property damage.**

## 7.0 REFERENCE MATERIALS

- [30.71: Series UM Universal Manifold Assembly](#)
- [30.72: Series UMC Universal Manifold Control Assembly](#)
- [10.54: FireLock™ Innovative Groove System IIGS™](#)
- [10.64: FireLock™ Installation-Ready™ Rigid Couplings Style 009N and Style 109](#)
- [30.74: Series ARV Adjustable Relief Valve](#)

### User Responsibility for Product Selection and Suitability

Each user bears final responsibility for making a determination as to the suitability of Victaulic products for a particular end-use application, in accordance with industry standards and project specifications, as well as Victaulic performance, maintenance, safety, and warning instructions. Nothing in this or any other document, nor any verbal recommendation, advice, or opinion from any Victaulic employee, shall be deemed to alter, vary, supersede, or waive any provision of Victaulic Company's standard conditions of sale, installation guide, or this disclaimer.

### Intellectual Property Rights

No statement contained herein concerning a possible or suggested use of any material, product, service, or design is intended, or should be construed, to grant any license under any patent or other intellectual property right of Victaulic or any of its subsidiaries or affiliates covering such use or design, or as a recommendation for the use of such material, product, service, or design in the infringement of any patent or other intellectual property right. The terms "Patented" or "Patent Pending" refer to design or utility patents or patent applications for articles and/or methods of use in the United States and/or other countries.

### Note

This product shall be manufactured by Victaulic or to Victaulic specifications. All products to be installed in accordance with current Victaulic installation/assembly instructions. Victaulic reserves the right to change product specifications, designs and standard equipment without notice and without incurring obligations.

### Installation

Reference should always be made to the Victaulic installation handbook or installation instructions of the product you are installing. Handbooks are included with each shipment of Victaulic products, providing complete installation and assembly data, and are available in PDF format on our website at [www.victaulic.com](http://www.victaulic.com).

### Warranty

Refer to the Warranty section of the current Price List or contact Victaulic for details.

### Trademarks

*Victaulic* and all other Victaulic marks are the trademarks or registered trademarks of Victaulic Company, and/or its affiliated entities, in the U.S. and/or other countries.